

## ***VERTICAL LATCHING LIQUID LEVEL CONTROLLERS WITH HIGH ALARM SWITCH***

The Series LC-91 is a corrosion resistant float type latching liquid level controller with an electrically independent high level alarm signal switch. The float and column wet end components are available in PVC, Polypropylene, and PVDF. The basic control function of this unit is to latch power on from a low latching set point to a high latching set point, and latch power on from a high latching set point to a low Latching set point. The high signal switch is activated when the liquid level is at or above the high switch set point. Custom variations are available upon request.

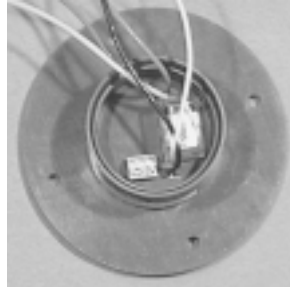

Downward view of  
LC-91 control head.

latching level switch should a power failure occur. This feature also allows the operator to drain a tank by momentarily interrupting the power at the breaker box.

The power down ground default function defaults to power down and eliminates column power should a wet end column breach occur, protecting the operator from potential electrical hazards.

Since the high alarm signal switch is electrically independent from the controller circuits, it can be wired to Ni-cad batteries or a separate electrical circuit (up to 230Vac) to provide further redundancy should a power failure occur or the controller circuit breaker trip.

### **SPECIAL FEATURES**

The Series LC-91 offers corrosion resistant water tight plastic construction. The latching control circuits incorporate a power interrupt power down reset function and a power down ground default. The electrically independent high level alarm signal switch provides additional redundancy should a mishap occur.

The power interrupt power down reset function defaults the liquid level controller to the power down mode in the event of a supply power interruption. Once the liquid level reaches the low latching control point, the controller resets and resumes normal function. This unique feature prevents the float from bypassing the high



### **APPLICATION**

Typical applications range from controlling valves, heaters, and pumps when automated filling and/or emptying is required. The controller can control a load of up to 10 amps resistive and motor loads to 1/2 hp directly. For larger loads the controller is reduced to pilot duty and easily operates large load contactors and motor starters. The high level switch is typically used for alarm lights and alarm horns up to 10 Watts or 12 Va. For larger loads the high level switch can easily operate control relays with up to a 10 Watt or 12Va inrush.

**Safe and Reliable Controller Selection** - In selecting a level controller, the total system design must be considered to assure safe, trouble-free performance. Controller function, material compatibility, adequate power ratings, proper installation, operation and maintenance are the responsibility of the system designer and user. Please feel free to ask for a copy of our Product Warranty.

## OPERATION

The Series LC-91 set points are factory hard wired magnetically sensitive switches, which are activated by the travel of the float containing specially oriented magnetic elements. The latching control circuits are capable of switching 10 amps using a variety or standard voltages. This unit is equipped with both a power "ON" from the low to the high latching set point, and power "ON" from the high to the low latching set point (See figure LC-91A). The high signal alarm switch is capable of switching 10 Watts up to 200Vdc or 12VA up to 230Vac.

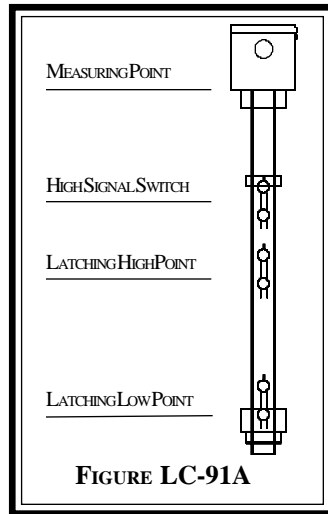

## ELECTRICAL LOAD

The load placed upon the liquid level controller is directly proportional to its expected service life and operational reliability.

The load is determined by the type of device being switched. Typical loads such as a heater, pump, relay, or solenoid valve all have their own load ratings. These ratings can be expressed in terms of watts, volt-amps, or amps. The term Watts or Volt-amp (VA) is usually associated with heater and relays, ie. a 20 watt solenoid valve. Pumps usually refer to amp draw which indicates the motor running amperage, ie. a 1/2 hp pump has a typical steady state draw of 8 amps.

Inductive loads usually refers to the load generated by a magnetic field used to produce some sort of motion. Devices such as a motor generates a motion because of a magnetic field in the armature and rotor. These devices have an initial inrush current of 5 to 12 times the running current which is cause by the initial generation of the magnetic field. That is to say, that until the magnetic field builds up and actually creates some sort of movement the current draw will always be significantly higher than the running current.

Resistive loads usually refer to devices such as heaters and electronic devices. These devices don't make use of magnetic fields to perform their functions. Hence there is no inrush current.

The latching level control circuits utilize a contact relay to handle loads up to 1/2 hp (inductive load) or 10 amps (resistive load). The maximum switching capacity graph

LC-91B must be used for determining the appropriate load placed upon the latching controller circuits.

The high level alarm signal switch can handle loads up to 10Watts or 12VA resistive in a wide range of voltages. The maximum switching capacity graph LC-91C must be used to determine the appropriate load to be placed upon this switch.

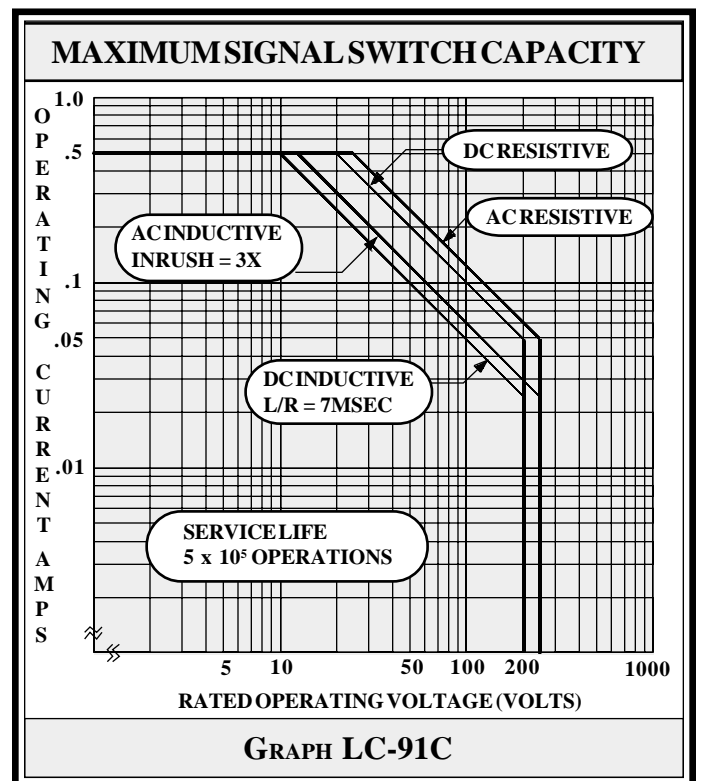
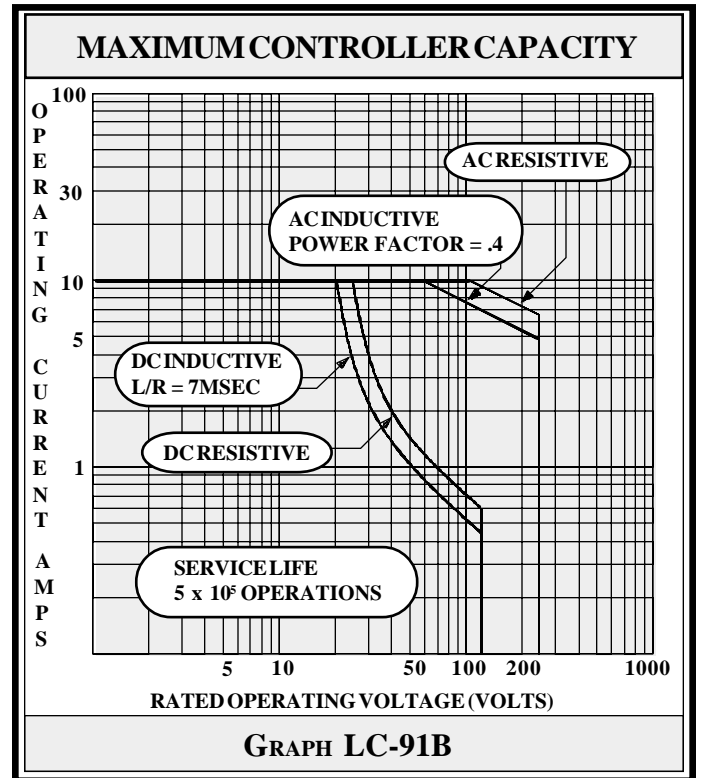

## ELECTRICAL LOAD EXAMPLE

For example, a 1/4 hp pump (AC Inductive Load) uses 4 amps and has an operating voltage of 120 volts AC. Using the graph LC-91B, find 120 volts on the voltage scale and draw a vertical line up. Next find the 4 amps on the amperage scale and draw a line horizontally. The intersection of these lines are below and to the left of the AC inductive limit line. This application will work. If the load was 10 amps at 120 Vac, the intersection of the lines would be above and to the right of the AC inductive limit line. You would have to use a heavy duty motor contactor and reduce the latching controller to pilot duty.

A high level alarm light (Resistive Load) has a bulb rating of 2.5 VA or .021 amps at 120 Vac. Using the same method above, but graph LC-91C, we find this application will work.

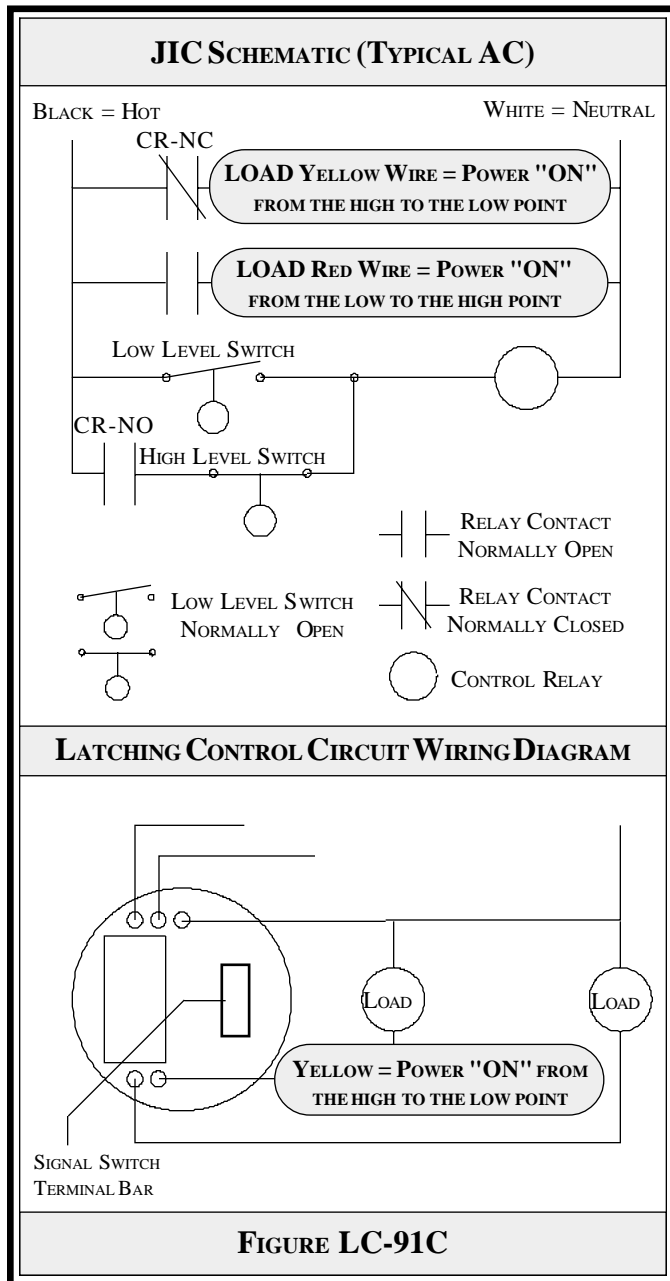

## HOW TO WIRE THE LOADS

The Series LC-91 latching controller circuits use 5 wires within the control head. The wires are color coded for ease of installation. For 120Vac models; White = Neutral, Black = Hot, Green = Ground, Red = Hot Power Switched "ON" from the low to high point, Yellow = Hot Power Switched "ON" from the high to low point.

The White, Black, and Green wires are power inputs from house power and the Red and Yellow wires are outputs to your load. The neutral (white) lead is wired in common with the load anywhere from the breaker panel up to and including the liquid level controller neutral input connection (See figure LC-91C).

If a heavy duty load contactor is required, your load simply becomes the coil on the load contactor.

The high level signal switch is wired via a numbered 3 pin terminal block (See Figure LC-91D).

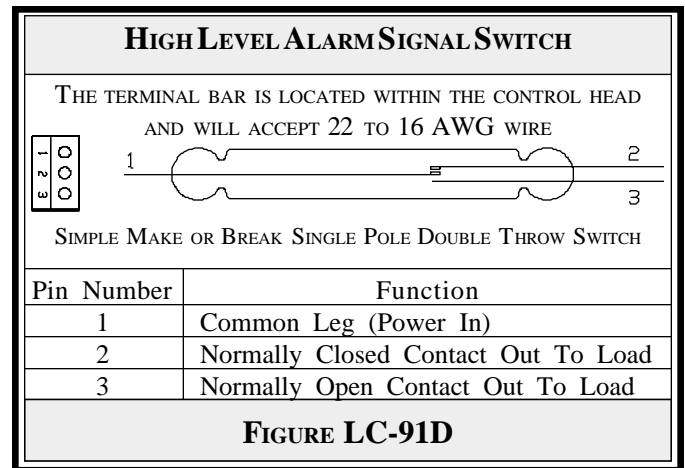

## HOW TO DETERMINE SET POINTS

The LC-91 utilizes 3 set points, a high signal switch set point, a high latch level point, and a low level latching point. The set points are measured from the measuring line (see Figure LC-91A and Figure LC-91E) to the actual switch triggering point in inches. The high signal switch distance is specified as "X" inches with the suffix HH. The high latching controller point distance is specified as "X" inches with the suffix H. The low level latching point is specified as "X" inches with the suffix L for low following it.

The overall column length will be 3 inches longer than the low level latching point unless otherwise specified at time of order. To specify a non-standard column length, simply add the actual overall column length as measured from the measuring line to the end of the column, to the set point data. Non-standard overall length is specified as "X" inches with the suffix OVL following it. See the "How to Order" example on the last page of the publication.

## DIMENSIONS (FIGURE LC-91E)

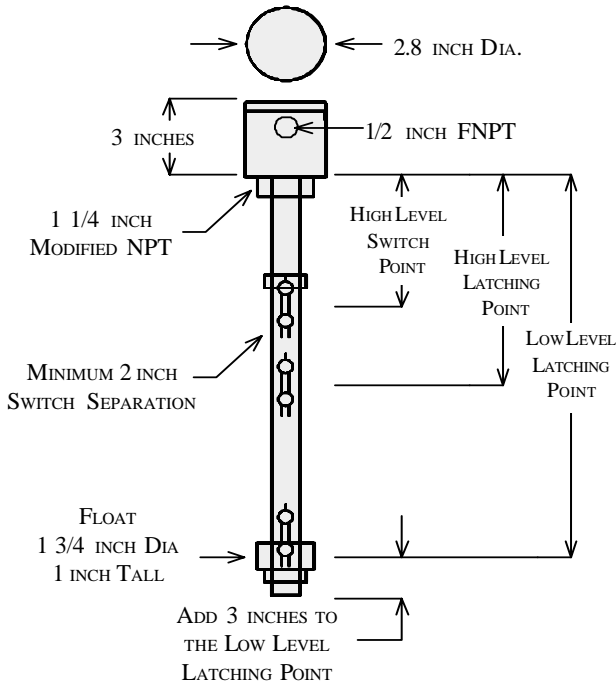

## LC-91 SPECIFICATIONS

**MATERIAL:** Polyvinyl Chloride (PVC)  
Polypropylene (PP)  
Polyvinylidene Fluoride (PVDF)

**WIRE:** 14 AWG Type THHN/THWN standard.  
High Signal Switch Terminal Bar 22-16AWG

**BUOYANCY:** 30% for Polyvinyl Chloride in H<sub>2</sub>O  
50% for Polypropylene in H<sub>2</sub>O  
30% for Polyvinylidene Fluoride in H<sub>2</sub>O

**MOUNTING ATTITUDE:** +/- 30 degrees in clean liquid

**COLUMN / TANK CLEARANCE:** Flush in clean liquid. 3 inches from the bottom of the tank in precipitate or sediment bearing liquids.

**HOUSING:** Water Tight. For outdoor installations a vent must be installed into the cap to prevent condensation due to temperature fluctuations.

**TEMPERATURE RANGE:** Control Head: 40°F-120°F

**WET END TEMPERATURE RANGE:**  
PVC: 32°F-140°F  
PP: 32°F-180°F  
PVDF: 32°F-210°F

**ANTI - TURBULENCE SHROUD:** Optional

**Mounting:** See Mounting Bracket Literature

## HOW TO ORDER

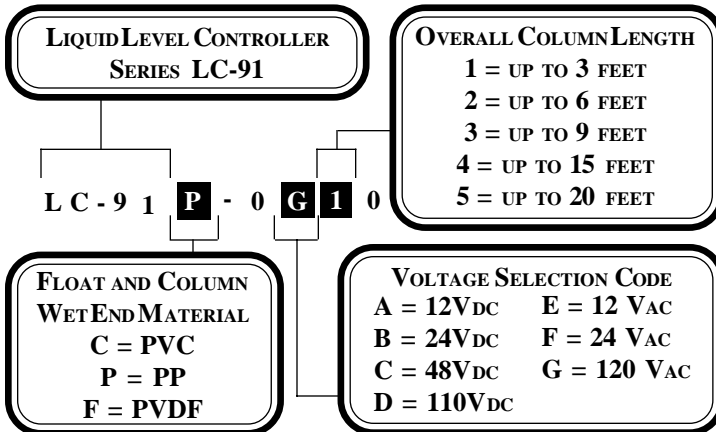

THE ACTUAL SET POINTS REQUIRED FOR YOUR SPECIFIC APPLICATION. DIMENSIONS ARE MEASURED FROM THE MEASURING LINE TO THE SWITCH TRIGGERING POINTS.

**x"HHx"Hx"L-x"OVL**  
(SEE FIGURE LC-91A & E)

PLEASE INCLUDE THIS INFORMATION IMMEDIATELY AFTER THE PART NUMBER

## EXAMPLE

A Latching Liquid Level Controller with a high alarm level switch is required to fill a tank. The pump must turn on at 24 inches from the top of the tank and shut off 6 inches from the top. If the tank continues to fill the high alarm switch will activate at 3 inches from the top of the tank. The wet end material that best fits the application is Polypropylene. The pump and alarm operates on 120 volts AC and is within the maximum switching capacity of the LC-91 Controller and high switch.

From the above we know the overall column length is 27 inches (24"+3"). The column Length Code is "1" (under 3 feet). The Material Code is "P" for Polypropylene. The Voltage Code is "G" for 120Vac. The high level signal switch is set at 3 inches. The latching set points are 6 inches and 24 inches (Orientation doesn't matter because the LC-91 has both power up and down channels).

The part number is simply LC-91P-0G10 with set points 3HH6H24L-27OVL

**VARIOUS TECHNOLOGIES INCORPORATED**  
2720 AIELLO DRIVE BUILDINGS C & D  
SAN JOSE, CALIFORNIA 95111  
PHONE (408) 972-4460 FAX (408) 972-4125

**Distributed by:**